

USM

TENSION / COMPRESSION TYPE LOAD CELL



REAL SIZE

Safe overload of 500%
 Compact tension / compression type load cell
 Ideal to measure tension,
 connectors mating quality check,
 experiments and more!



Flexible cable

● Wiring diagram

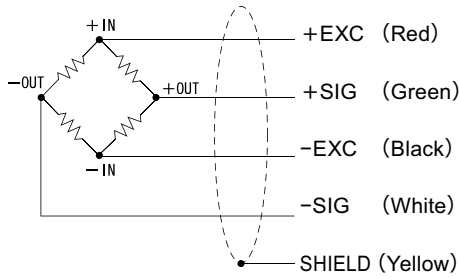

● Very compact

Space-saving design.
 Ideal for side-by-side installation too.

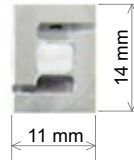

Specifications

Model	USM-1N, USM-2N	USM-5N, USM-10N USM-20N, USM-50N
Rated capacity	1 N, 2 N	5 N, 10 N, 20 N, 50 N
Rated output	Approx. 0.4 mV/V	
Safe overload	500% R.C.	
Zero balance	±0.5 mV/V	±0.3 mV/V
Non-linearity	0.2 % or less R.O.	0.1 % or less R.O.
Hysteresis	0.2 % or less R.O.	0.1 % or less R.O.
Repeatability	0.1 % or less R.O.	
Compensated temperature range	-10 to +60°C	
Safe temperature range	-20 to +70°C	
Temperature effect on zero	3% R.O./10°C or below	1% R.O./10°C or below
Temperature effect on span	1% R.O./10°C or below	
Input resistance	Approx. 1000 Ω	
Output resistance	Approx. 1000 Ω	
Recommended excitation voltage	5 V	
Maximum excitation voltage	7.5 V	
Insulation resistance (DC 50 V)	1000 MΩ or more	
Cable	φ2 4-conductor flexible cable 1 m Cable end: 5 wires	
Load cell material	Aluminum alloy	
RoHS directives	2011/65/EU (EU)2015/863	

● Easy to install

Two tapped holes
 at both hands enable easier
 connections to the actuator.



● Great durability

Load cell frequently
 gets damaged especially
 in small force measurement,
 and cable is easily broken.

▶ Safe overload of 500%!
 Using high durability
 robot cable!

External dimension

■ USM-1N/2N

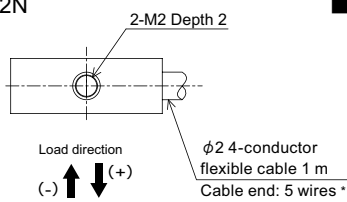

■ USM-5N/10N/20N/50N

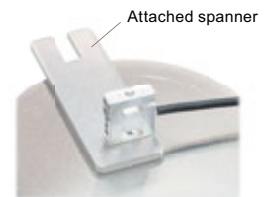
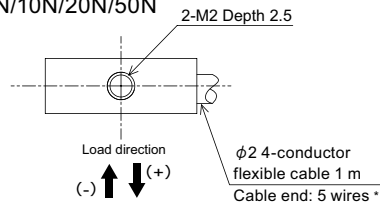

USM is a load cell with small rated capacity.
 Make sure to use the attached spanner
 when mounting.

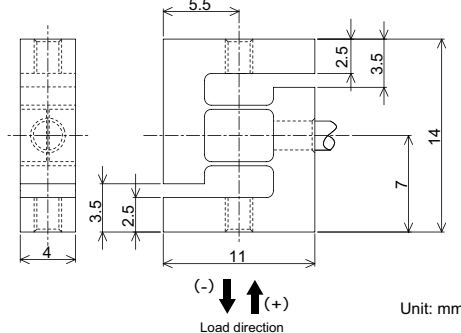
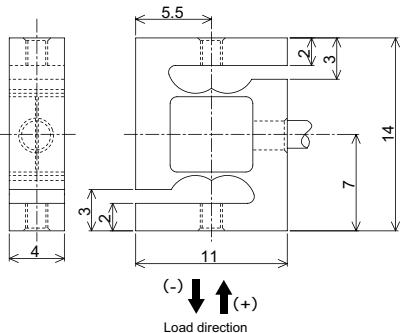

Unit: mm

Model	Deflection at rated	Natural frequency	Weight
USM-1N	0.006 mm	2.7 kHz	2 g
USM-2N	0.007 mm	3.1 kHz	2 g
USM-5N	0.005 mm	3.8 kHz	3 g
USM-10N	0.011 mm	3.3 kHz	3 g
USM-20N	0.011 mm	4.1 kHz	3 g
USM-50N	0.023 mm	4.3 kHz	3 g

* Connector can be attached to the cable according to your requests. Refer to 84 pages for details.

Optional accessories

■ USM-LB3

A load button which helps
 measuring compression force.

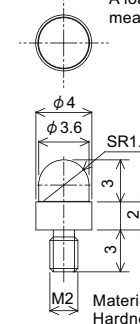

An example of mounting

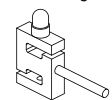

Material: Steel
 Hardness: more than HRC50